













1  <b>Cam Lock</b> 10 Pcs	2  <b>Klix Cam</b> 10 Pcs	3  <b>Housing Cap (Short)</b> 6 Pcs	4  <b>Housing Cap (Long)</b> 4 Pcs	5  <b>Adjustable Glide</b> 4 Pcs	6  <b>6 Hole L-Bracket</b> 5 Pcs	7  <b>Screw #8 x 5/8"</b> 30 Pcs	8  <b>M4 x 65 Allen-Key</b> 1 Pc
---	---	---	--	--	--	--	--

<b>A</b>  <b>Top Panel</b>	<b>B</b>  <b>Back Panel</b>	<b>C</b>  <b>Left Side Panel</b>	<b>D</b>  <b>Right Side Panel</b>
---	--	---	--

**KLIX CAM INSTRUCTIONS**

1  <b>Line up Cam Lock, turn clockwise.</b>	2  <b>Insert the cam with the arrow pointing towards the hole in the edge.</b>	3  <b>Insert the Cam Lock into Klix Cam. Turn Klix Cam to lock.</b>
--	---	---

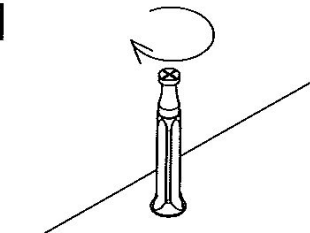
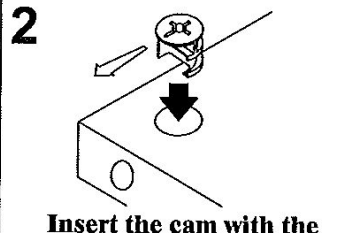
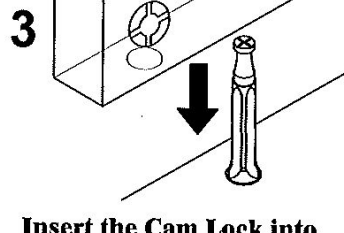
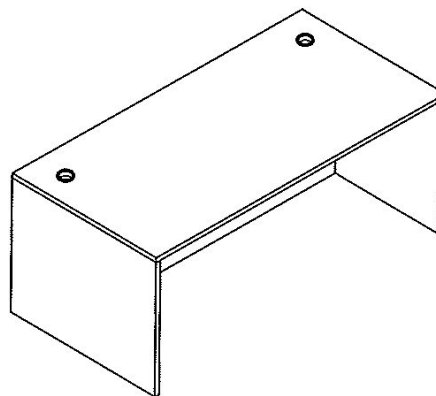

**IMPORTANT :**

- Place all wooden parts on a clean and smooth surface such as a rug or carpet to avoid the parts from being scratched.
- Check to be sure that you have all parts and hardware.
- Remove all wrapping materials, including staples & packing straps before you start to assemble.
- Do not tighten screws/bolts until the unit is completely assembled.
- Keep all hardware parts out of reach of children.

