











1  Cam Lock 13 Pcs	2  Klix Cam 13 Pcs	3  Housing Cap (Long) 6 Pcs Housing Cap (Short) 7 Pcs	4  Adjustable Glide 4 Pcs	5  6 Hole L-Bracket 5 Pcs	6  Screw #8 x 5/8" 30 Pcs	7  M4 x 65 Allen-Key 1 Pc
---	---	---	--	---	---	--

A  Top Panel	B  Back Panel	C  Left Side Panel	D  Right Side Panel
---	--	---	--

KLIX CAM INSTRUCTIONS

1  Line up Cam Lock, turn clockwise.	2  Insert the cam with the arrow pointing towards the hole in the edge.	3  Insert the Cam Lock into Klix Cam. Turn Klix Cam to lock.
--	---	--

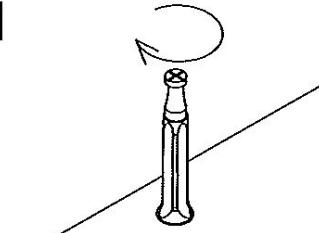
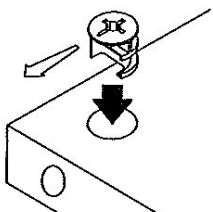
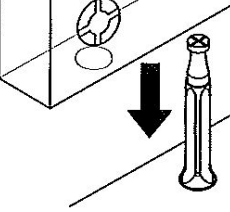
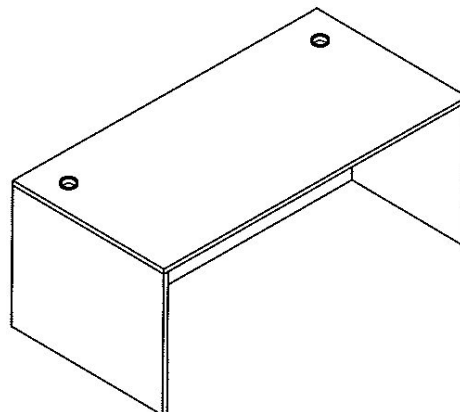

IMPORTANT :

- Place all wooden parts on a clean and smooth surface such as a rug or carpet to avoid the parts from being scratched.
- Check to be sure that you have all parts and hardware.
- Remove all wrapping materials, including staples & packing straps before you start to assemble.
- Do not tighten screws/bolts until the unit is completely assembled.
- Keep all hardware parts out of reach of children.

